

OUT. 20

ABK

EMOZIONI IN SUPERFICIE

OUT. 20

ABK
EMOZIONI IN SUPERFICIE

OUTDOOR DESIGN

OUT.20 è il contenitore di soluzioni progettuali per l'outdoor in gres porcellanato, a spessore 20 mm, contenente le ispirazioni materiche delle principali collezioni ABK. La gamma OUT.20, oltre ad offrire elevate prestazioni tecniche, è stata studiata per offrire massima libertà creativa, anche grazie ai diversi formati. L'elevata resistenza ad ogni carico e sollecitazione, oltre alla garanzia di inalterabilità in tutte le condizioni atmosferiche, fanno di OUT.20 un prodotto ideale per la creazione di aree esterne calpestabili nei contesti più svariati, come giardini, bar, ristoranti, terrazze, balconi, zone bordo piscina, solarium e stabilimenti balneari.

OUTDOOR DESIGN

OUT.20 is the collection of 20 mm thick outdoor porcelain pavers inspired by the materials from ABK's most important ranges. The OUT.20 range combines outstanding technical performance with the utmost creative freedom and is available in various sizes. With its high load and stress resistance and the ability to withstand even the most severe atmospheric conditions, OUT.20 is ideal for use in heavy foot traffic areas in a wide range of settings including gardens, bars, restaurants, terraces, balconies, swimming pool surrounds, solariums and bathing establishments.



floor
OUT.20 ATLANTIS SMOKE HAMMERED 60x90 20 mm

I VANTAGGI DEL GRES PORCELLANATO DA ESTERNO

Un pavimento in gres porcellanato rappresenta un'ottima soluzione per l'outdoor, perché bello e resistente allo stesso tempo. L'ampia gamma OUT.20 viene prodotta in Italia in modo sostenibile attraverso la pressatura di una miscela di materiali naturali, tra cui sabbie e argille. La cottura a temperature estremamente elevate elimina completamente l'umidità, dando vita ad un materiale privo di porosità e incredibilmente resistente. Le nostre superfici in gres porcellanato, oltre ad essere durevoli e di facile manutenzione, offrono la bellezza e lo stile tipici del design italiano, al quale si aggiungono la garanzia di sostenibilità dei processi produttivi ed il know how tecnico e commerciale di chi ha già maturato una pluriennale esperienza nel settore ceramico.

THE BENEFITS OF OUTDOOR PORCELAIN

Porcelain paving is both beautiful and hardwearing. OUT.20 tiles are sustainably produced in Italy by pressing a combination of natural materials, including clays and sands. They are then fired at extremely high temperatures to remove all the moisture and create an incredibly durable, nonporous product. Our porcelain products combine unbeatable durability and ease of maintenance with the beauty and style of Italian design, as well as the assurance of sustainable manufacture and the full sales and technical support of a company with many years of experience in the ceramic sector.

SOSTENIBILITÀ

OUT.20 non significa solo qualità, ma anche massima attenzione alle tematiche di sostenibilità ambientale. ABK da anni ormai ha attuato all'interno dei propri processi produttivi una serie di azioni concrete, riducendo le emissioni al di sotto delle normative vigenti, recuperando al 100% l'acqua e i materiali residui e abbassando i consumi di energia attraverso appositi dispositivi di recupero negli impianti. Il gres porcellanato è un materiale inerte, riciclabile al 100%, un prodotto ABK è doppiamente sostenibile, perché gli impasti ceramici utilizzati hanno ottenuto dal 2013 la certificazione Ecobody, in quanto contenenti un 40% minimo di materie prime di qualità recuperate da altri processi produttivi. I prodotti realizzati con impasto Ecobody concorrono all'acquisizione dei crediti leed (leadership in energy and environmental design).

SUSTAINABILITY

OUT.20 stands for the best in manufacturing quality as well as exceptional green credentials and environmental sustainability. For years now, ABK has always adopted robust and advanced environmental measures in its production processes and is committed to low emission levels, 100% water recycling, reuse of all processing residues and reduced energy consumption through heat recovery and transfer processes. Porcelain stoneware is an inert, 100% recyclable material. An ABK product is a doubly sustainable choice because the ceramic bodies have been certified as Ecobody since 2013, which means they contain at least 40% high-quality raw materials recycled from other production processes. Products made from Ecobody qualify for leed credits (leadership in energy and environmental design).



PERCHÈ SCEGLIERE LA CERAMICA

WHY CHOOSE CERAMICS



SICURA

La ceramica è un materiale sicuro, che viene dalla terra, quindi naturale, non contiene plastica ed è completamente riciclabile.

SAFE

Ceramic is a safe, natural material that originates from the earth. It does not contain plastic and is completely recyclable.



IGIENICO

La ceramica è uno dei materiali più igienici, non fa odore, si pulisce facilmente con tutti i prodotti per la pulizia della casa.

HYGIENIC

Ceramic is one of the most hygienic of all materials. It's odourless and easy to clean using any household detergent.



DURA A LUNGO

La ceramica è un materiale duraturo, inalterabile, si pulisce facilmente ed è sempre come nuovo anche col passare del tempo.

LONG - LASTING

Ceramic is a durable and hard-wearing material. It's easy to clean and always looks as good as new.



NON BRUCIA

In caso di incendio, la ceramica non rilascia sostanze nocive, né per l'uomo né per l'ambiente, perché non brucia.

IT DOES NOT BURN

It does not burn and in the event of fire does not release substances that are harmful to people or the environment.



RESISTENTE

La ceramica è un materiale forte perché non si deforma, non gela e resiste ai detergenti chimici più aggressivi.

RESISTANT

Ceramic is a strong material that does not deform or freeze and is resistant to even the most aggressive chemical detergents.



VERSATILE

La ceramica - con la sua infinita varietà di formati e superfici - è adatta per ogni ambiente, ideale per pavimenti e pareti, per piani di lavoro e tavoli.

VERSATILE

With its infinite variety of sizes and surfaces, ceramic is suitable for any application, whether floors or walls, countertops or tables.



STABILE

Un pavimento in ceramica è pratico e stabile e si posa facilmente nei negozi, nei ristoranti, negli uffici e in ogni tipo di locale.

STABLE

A ceramic floor is practical, stable and easy to install in shops, restaurants, offices and any other location.



AMA L'AMBIENTE

La ceramica è un materiale sostenibile, rispetta l'ambiente e la salute perché è prodotta in conformità con tutte le normative europee.

ENVIRONMENT - FRIENDLY

Ceramic is a sustainable material that is healthy and environment-friendly because it is produced in full compliance with European standards.



COMPLETEZZA E CURA DEL DETTAGLIO

ABK sa che ogni progetto è unico e che i dettagli, anche nella costruzione degli spazi esterni, fanno la differenza. Per questo la gamma dei pavimenti per esterni è completata da una vasta selezione di pezzi speciali, con cui rivestire gradini, marciapiedi e zone carrabili. Per le piscine sono disponibili le apposite griglie di drenaggio che si integrano perfettamente con la pavimentazione."

COMPLETENESS AND ATTENTION TO DETAIL

At ABK we understand that it's the little extras and finishing touches that make all the difference to your outdoor space. This is why the range of outdoor paving is complemented by a wide selection of special trims, for use on steps, pavements and driveways. For swimming pools, special drainage gratings are available for seamless integration with the paving tiles.

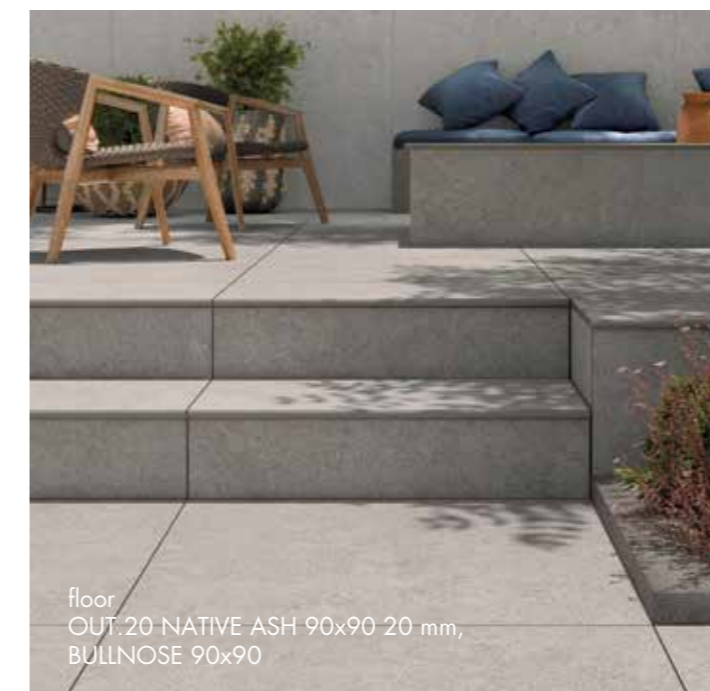

floor
OUT_20 NATIVE ASH 90x90 20 mm,
BULLNOSE 90x90



floor
OUT_20 DOLPHIN CLAY 30x120 20 mm,
ELEMENTO L 15x60x5

SCOPRI LE SUPERFICI ABK

DISCOVER THE ABK SURFACES

CONTEMPORANEO

Per un giardino dal mood contemporaneo, ABK ha esplorato il mondo dei cementi, dai più minimalisti ai più particolari, come i suggestivi effetti dell'intonaco scrostato.

CONTEMPORARY

For a contemporary style garden, ABK has explored the world of concrete, from the most minimalist to the more unique ones, such as the visual effect of decayed plaster.



PIETRA

Cosa ci può essere di più autentico e prezioso di una pavimentazione in pietra o marmo? Il gres porcellanato è in grado di riprodurre la naturale variabilità, così come la sensazione materica.

STONE

What could be more authentic and appealing than a stone or marble floor? Porcelain reproduces the natural variability and texture of these materials.

LEGNO

ABK offre una variegata gamma di gres porcellanato effetto legno, adatta a tutti i gusti, dalle linee pulite ed eleganti alle finiture rustiche e recuperate.

WOOD

With one of the largest ranges of external wooden porcelain, ABK created a varied collection to suit all tastes; from clean lines and elegant finishes to reclaimed and rustic finishes.



MATERIALI

MATERIALS

PIETRA E MARMO

STONE AND MARBLE

TRANI BEIGE	PIRENEI ECRU	PIRENEI GREY	CREAM	IVORY
MOON HAMMERED	SAND	SAND HAMMERED	PIASE ASH	PIASE MUD
			GREIGE	FOG
			GREY HAMMERED	SMOKE HAMMERED
			ASH	FOG

SENSI ROMA
60x120

PAG 10

POETRY STONE

120x120
60x120

PAG 12

MONOLITH

60x120
60x60

PAG 14

ATLANTIS

60x90

PAG 16

NATIVE

90x90

PAG 18

CONTEMPORANEO

CONTEMPORARY

MOON	ASH	GREY
BASE SAND	BASE ASH	BASE TAUPE
	FORM ASH	FORM TAUPE
	ROPE	GREY

BLEND CONCRETE

60x120
90x90

PAG 22

LAB325

60x120
60x60

PAG 26

GHOST

90x90
60x60

PAG 28

LEGNO

WOOD

	GOLD	OAK
	NATURALE	AVANA
GREY	CLAY	OAK
	NATURALE	AVANA

POETRY WOOD

30x120
30x180

PAG 30

ECO CHIC

30x180

PAG 32

DOLPHIN

30x120

PAG 36

SOLERAS

30x120

PAG 38

OUT. 20

SENSI ROMA

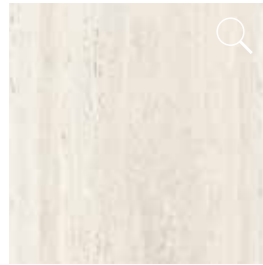

60x120
IVORY
0012556 rett

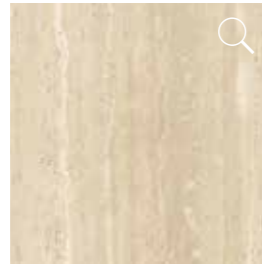

60x120
CREAM
0012557 rett

▼
20 mm
▲

Formato | Size
60x120 cm | 24"x48"

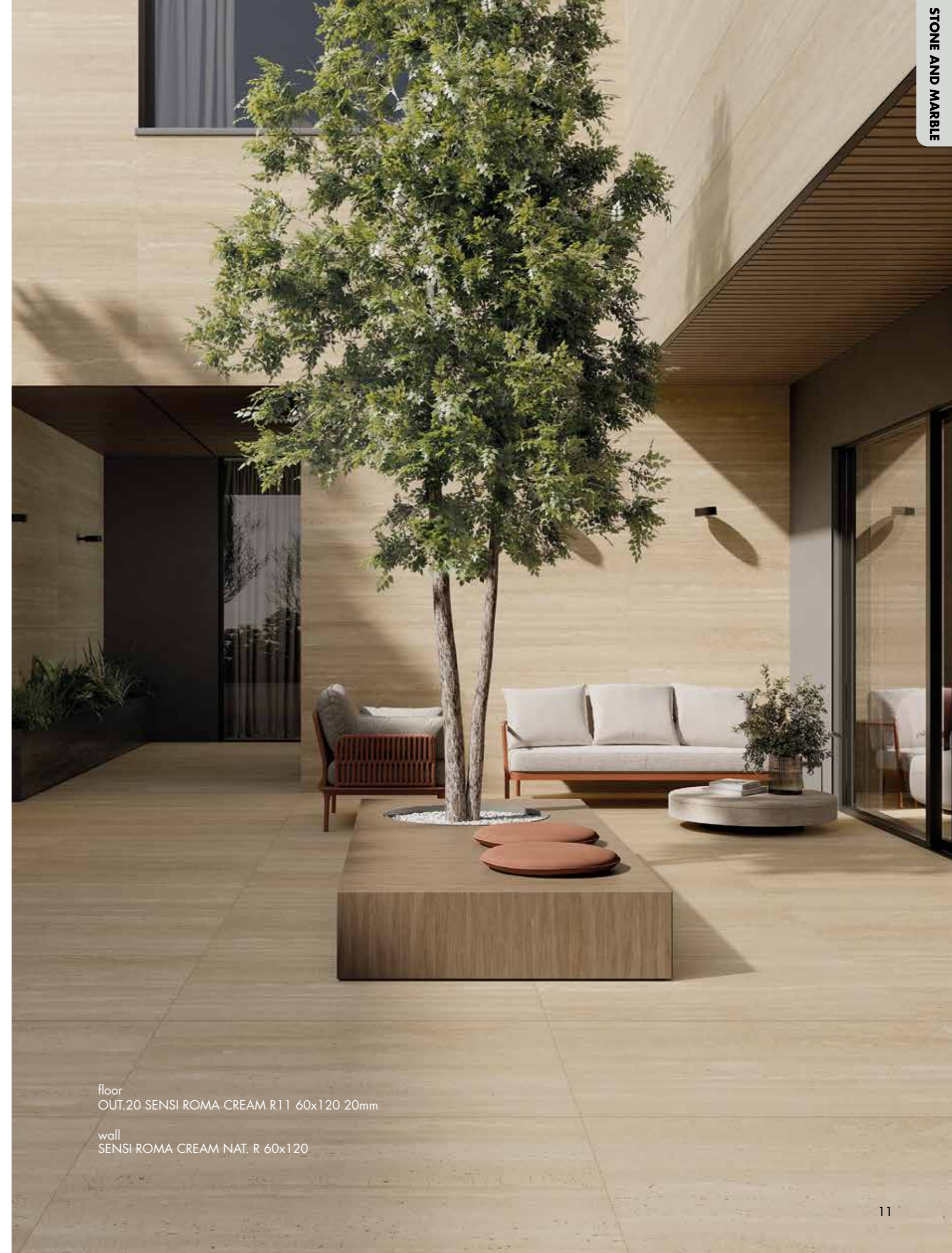
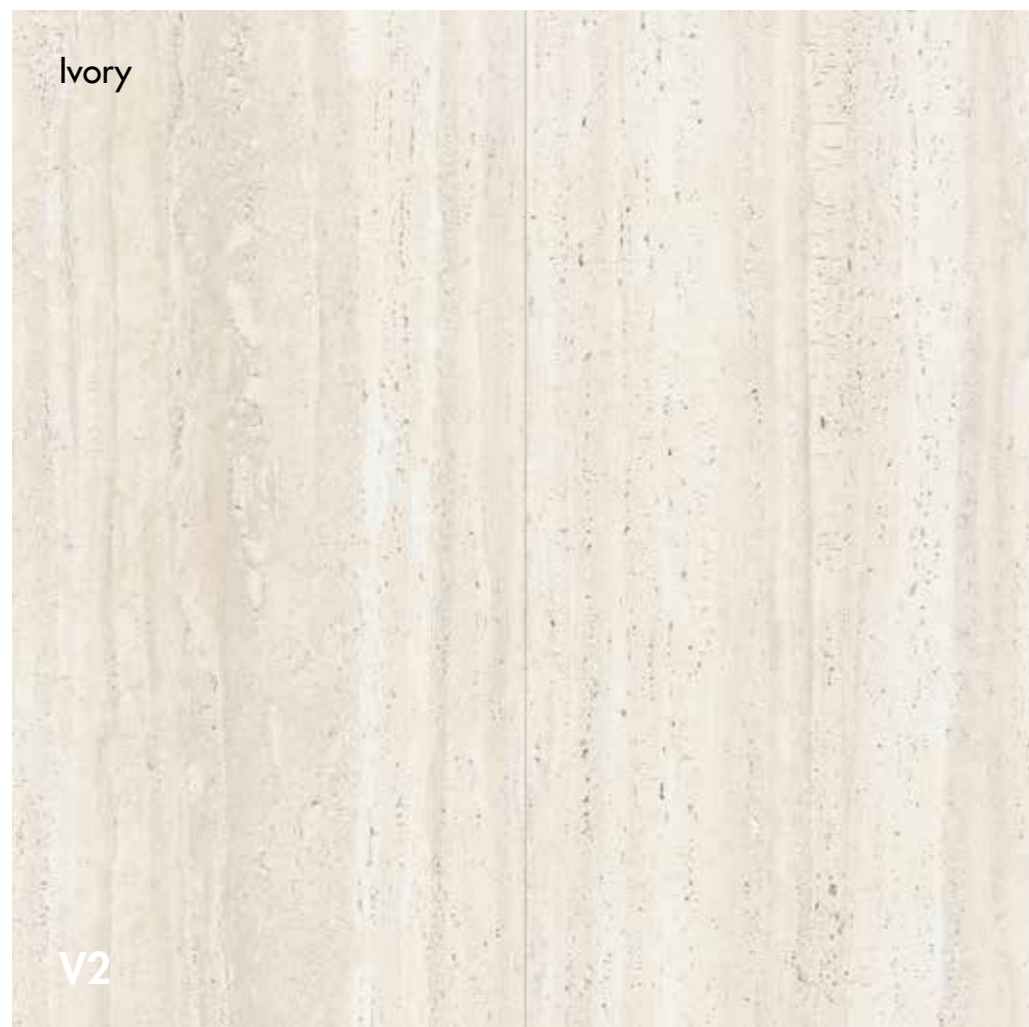

floor
OUT.20 SENSI ROMA CREAM R11 60x120 20mm

wall
SENSI ROMA CREAM NAT. R 60x120

OUT. 20

POETRY STONE

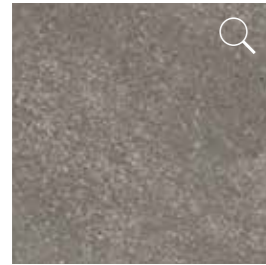

60x120
PIASE MUD
0010206 rett



60x120
PIASE ASH
0010205 rett



60x120
PIRENEI GREY
0006356 rett

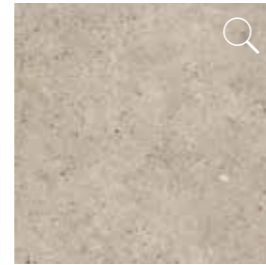

60x120
PIRENEI ECRU
0006354 rett

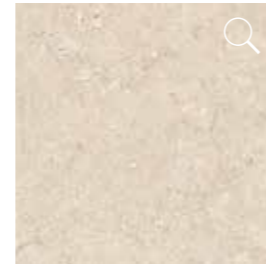

60x120
TRANI BEIGE
0010632 rett

▼
20 mm
▲

Formato | Size
60x120 cm | 24"x48"



floor
OUT.20 PIASE ASH R11 60x120 20 mm

OUT. 20

MONOLITH



60x60
FOG
0013511 rett

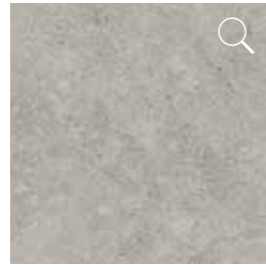

60x60
GREIGE
0013512 rett

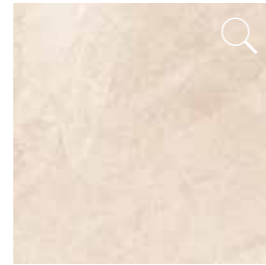

60x60
SAND
0013513 rett

▼
20 mm
▲

Formato | Size
60x60 cm | 24"x24" - 60x120 cm | 24"x48"

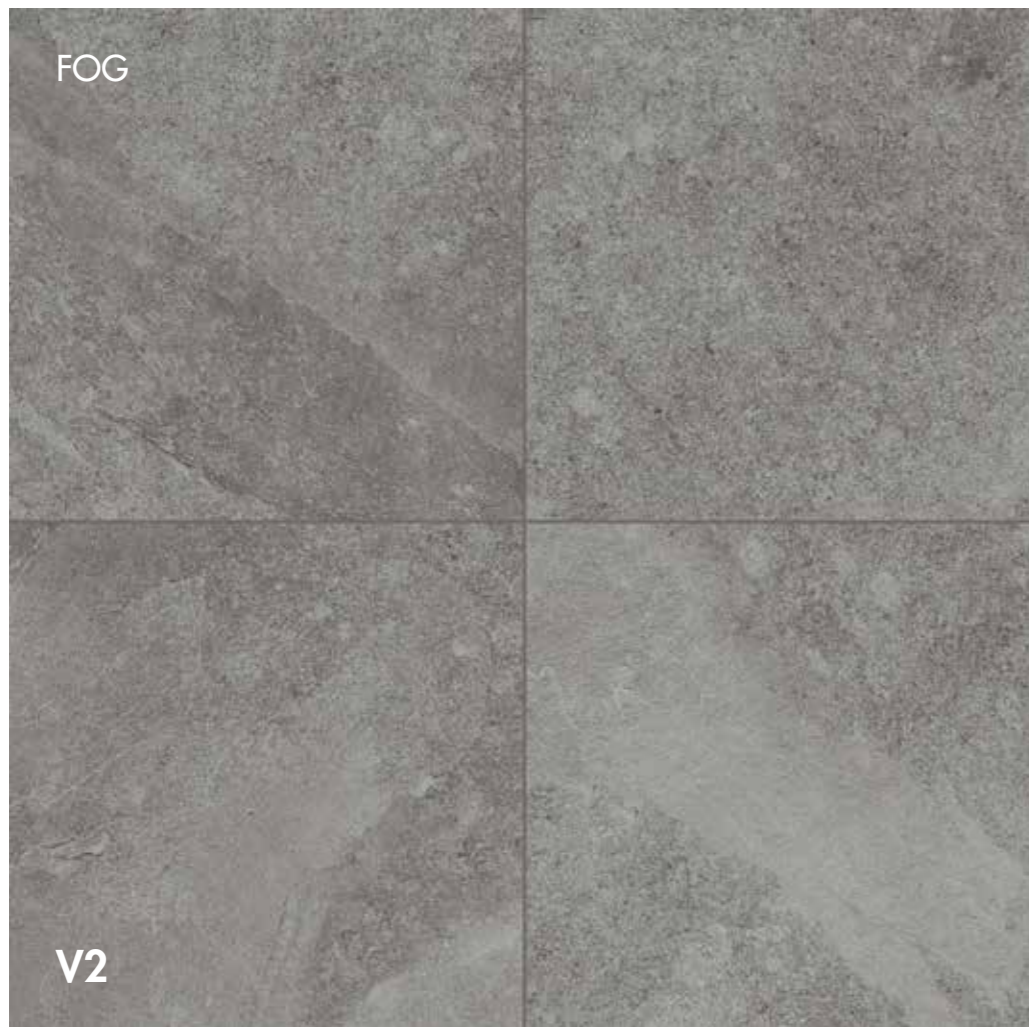

FOG

V2



floor
OUT.20 MONOLITH GREIGE RETT 60x60 20 mm

OUT. 20

ATLANTIS

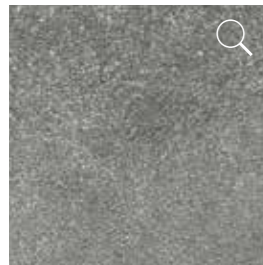

60x90
ATLANTIS SMOKE HAMMERED
0007175 rett



60x90
ATLANTIS GREY HAMMERED
0007174 rett

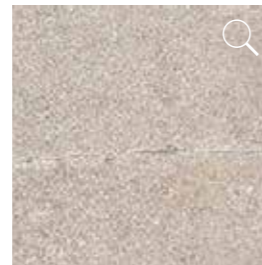

60x90
ATLANTIS SAND HAMMERED
0007176 rett

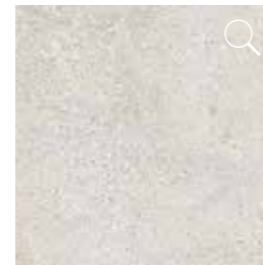

60x90
ATLANTIS MOON HAMMERED
0007780 rett

▼
20 mm
▲

Formato | Size
60x90 cm | 24"x36"

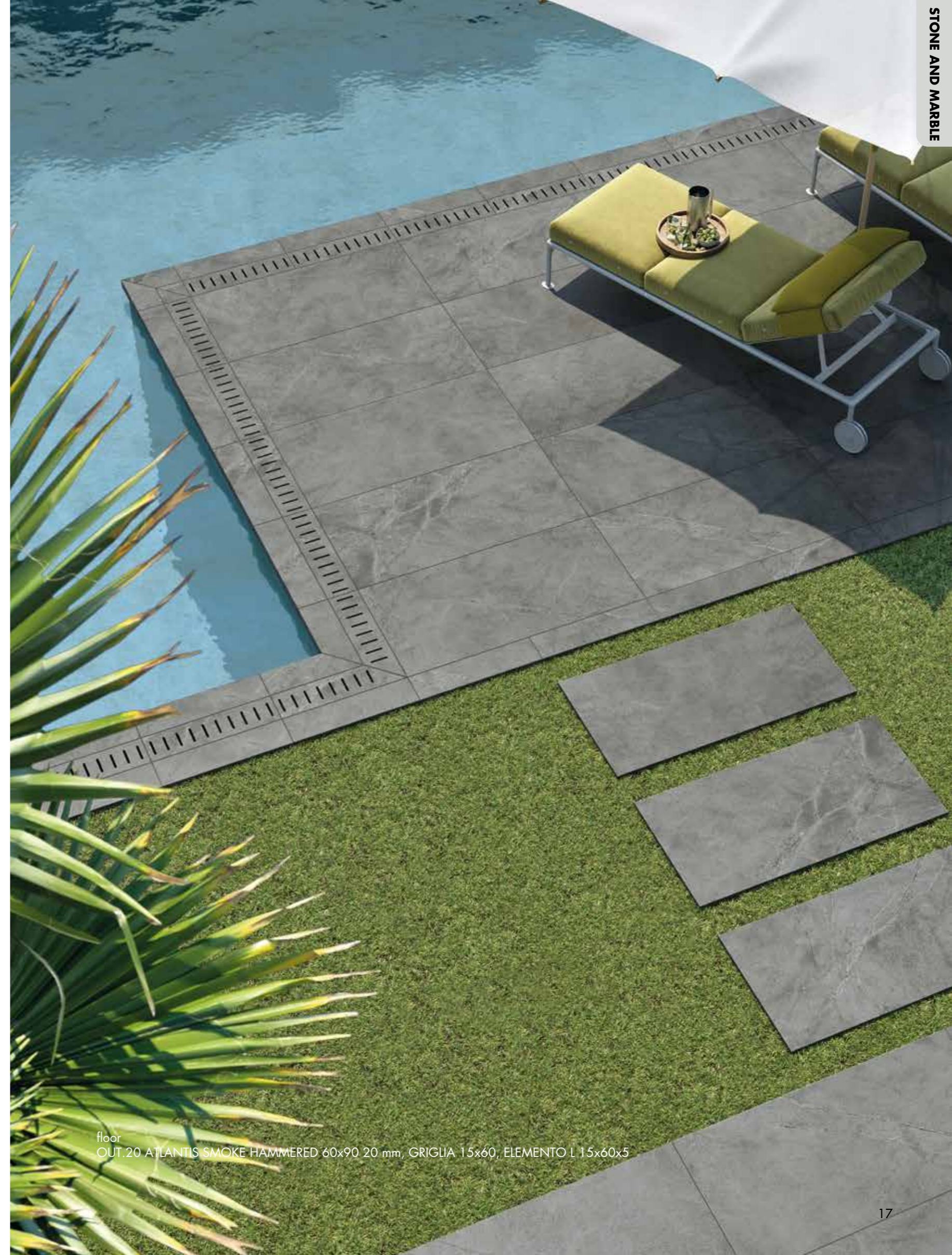
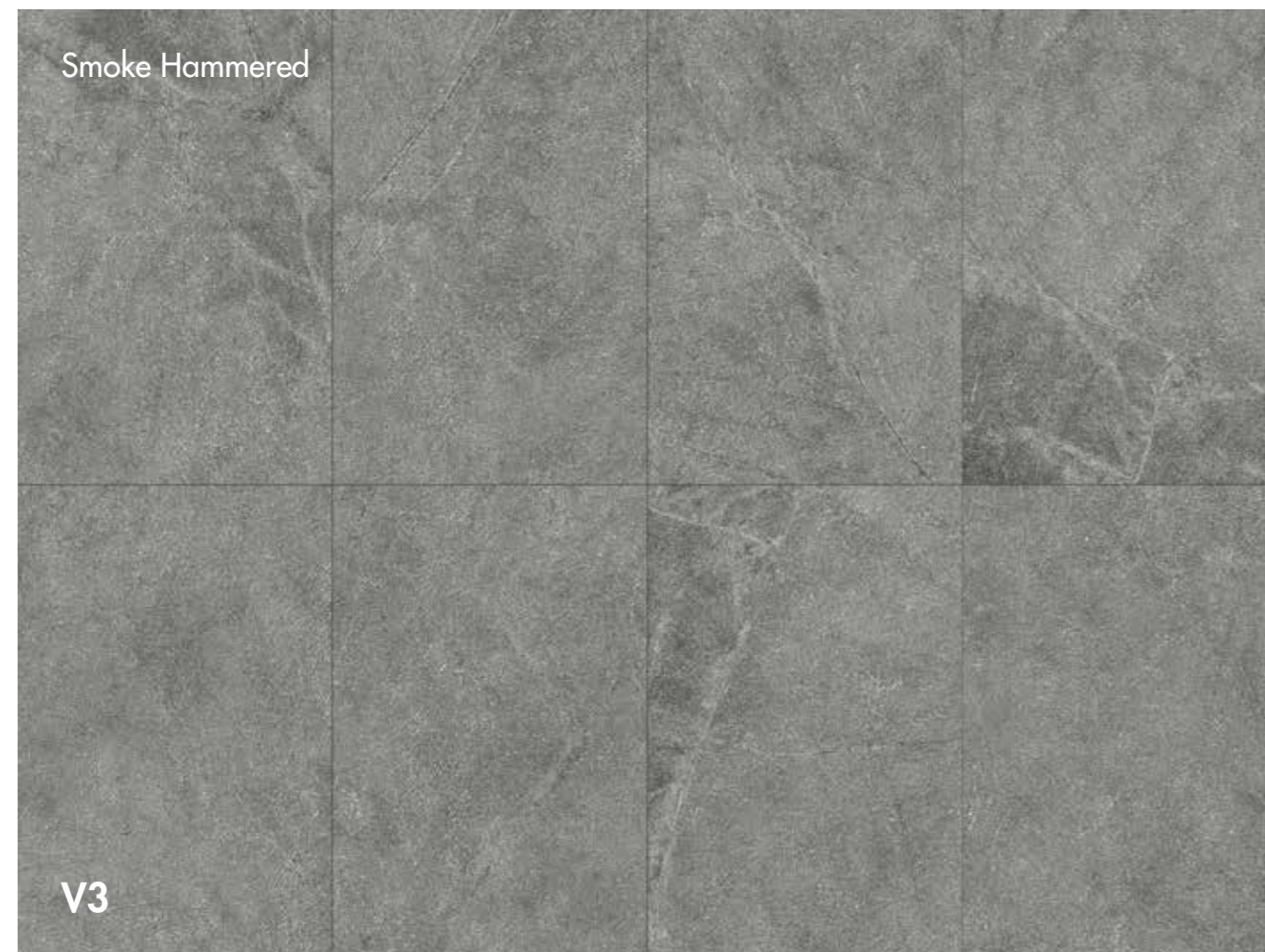

floor
OUT.20 ATLANTIS SMOKE HAMMERED 60x90 20 mm, GRIGLIA 15x60, ELEMENTO I 15x60x5

OUT. 20

NATIVE



90x90
NATIVE FOG
0004220 rett

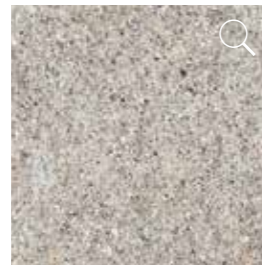

90x90
NATIVE ASH
0004219 rett

▼
20 mm
▲

Formato | Size
90x90 cm | 36"x36"

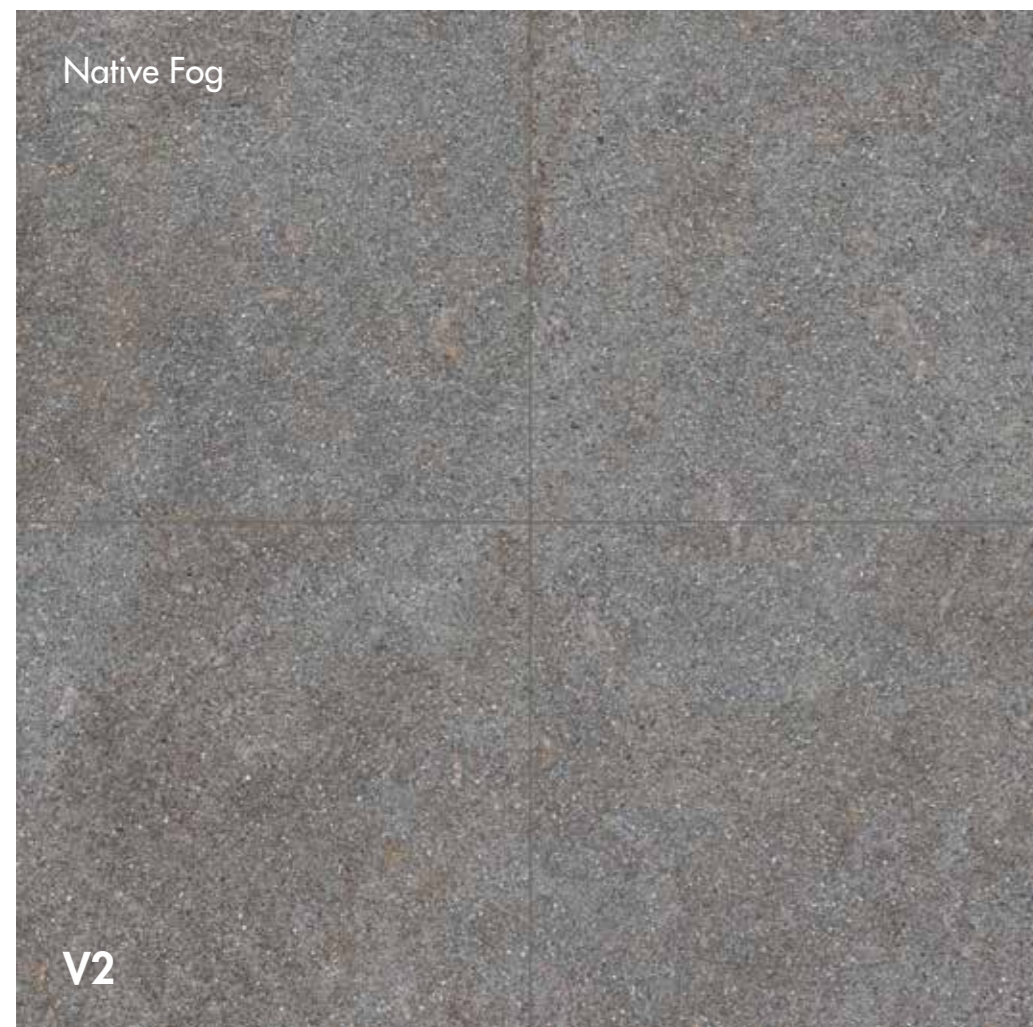

floor
OUT.20 NATIVE FOG 90x90 20 mm



bench
NATIVE FOG 160x320

volume top
OUT.20 NATIVE FOG 90x90 20 mm

floor
OUT.20 NATIVE ASH 90x90 20 mm, BULLNOSE NATIVE ASH

wall
NATIVE ASH 160x320

OUT. 20

BLEND CONCRETE

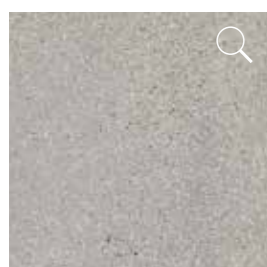

60x120
BLEND CONCRETE ASH
0007024 rett

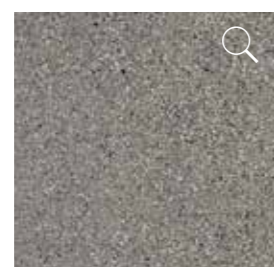

90x90
BLEND CONCRETE GREY
0006019 rett

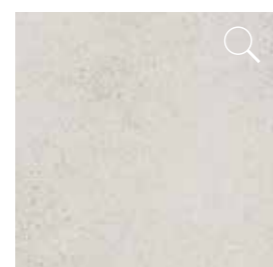

90x90
BLEND CONCRETE MOON
0008947 rett

Formato | Size
60x120 cm | 24"x48"

▼
20 mm
▲

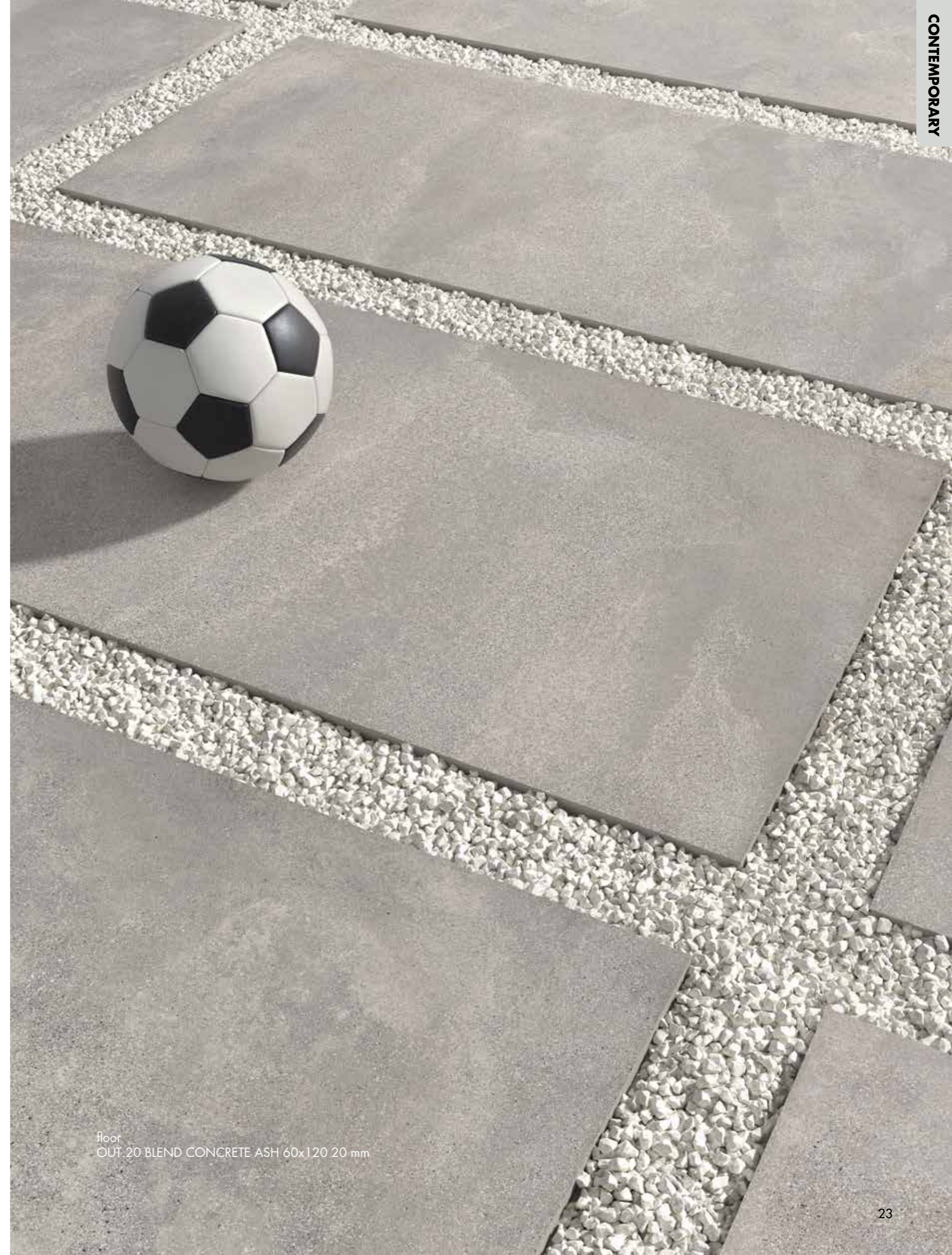

floor
OUT. 20 BLEND CONCRETE ASH 60x120 20 mm



floor
OUT.20 BLEND CONCRETE GREY 90x90 20 mm

OUT. 20

LAB325



60x120
LAB325 BASE TAUPE
0002706 rett



60x120
LAB325 FORM TAUPE
0002704 rett



60x120
LAB325 BASE ASH
0002705 rett
60x60
LAB325 BASE ASH
0012163 rett



60x120
LAB325 FORM ASH
0002703 rett



60x60
LAB325 BASE SAND
0012164 rett

Formato | Size
60x120 cm | 24"x48"

▼
20 mm
▲



floor
OUT.20 LAB325 FORM TAUPE 60x120 20 mm

OUT. 20

GHOST

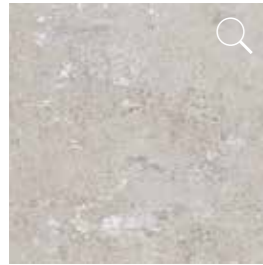

90x90
GHOST ROPE
0004588 rett
60x60
GHOST ROPE
0015265 rett

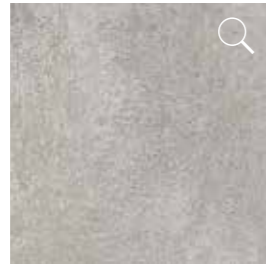

90x90
GHOST GREY
0004587 rett
60x60
GHOST GREY
0015264 rett

Formato | Size
90x90 cm | 36"x36"

20 mm



floor
OUT. 20 GHOST ROPE 90x90 20 mm

OUT. 20

POETRY WOOD

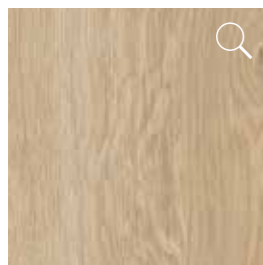

30x180
POETRY WOOD GOLD
0010078 rett

30x120
POETRY WOOD GOLD
0010081 rett

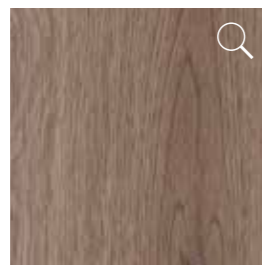

30x180
POETRY WOOD OAK
0010079 rett

30x120
POETRY WOOD OAK
0010082 rett

Formato | Size
30x180 cm | 12"x72" - 30x120 cm | 12"x48"

20 mm



V2

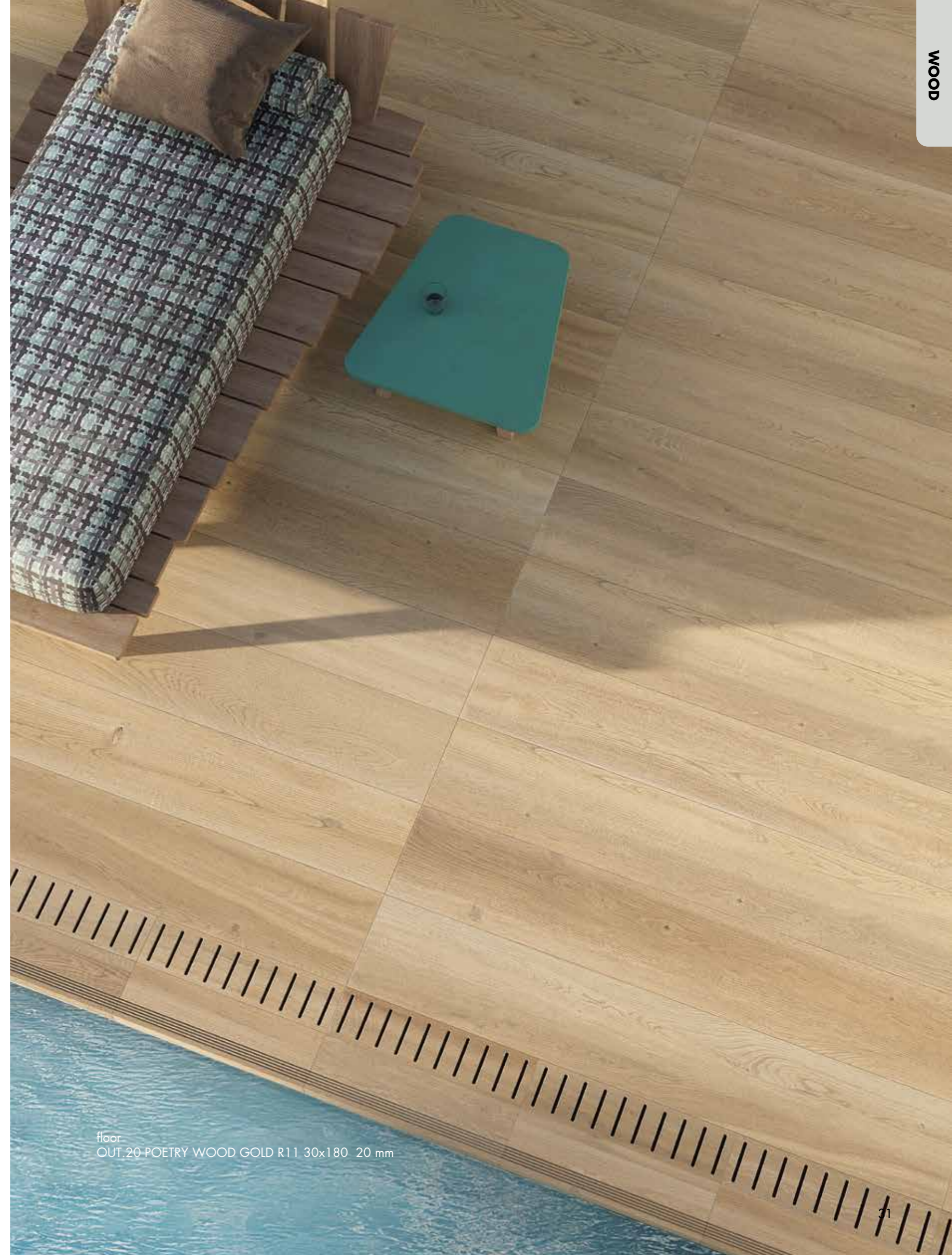

WOOD

floor
OUT_20 POETRY WOOD GOLD R11 30x180 20 mm

OUT. 20

ECO CHIC

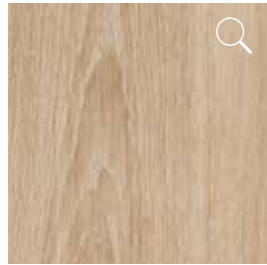

30x180
ECO CHIC NATURALE
0006377 rett

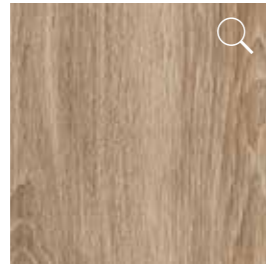

30x180
ECO CHIC AVANA
0006378 rett

▼
20 mm
▲

Formato | Size
30x180 cm | 12"x72"



Eco Chic Naturale

V2

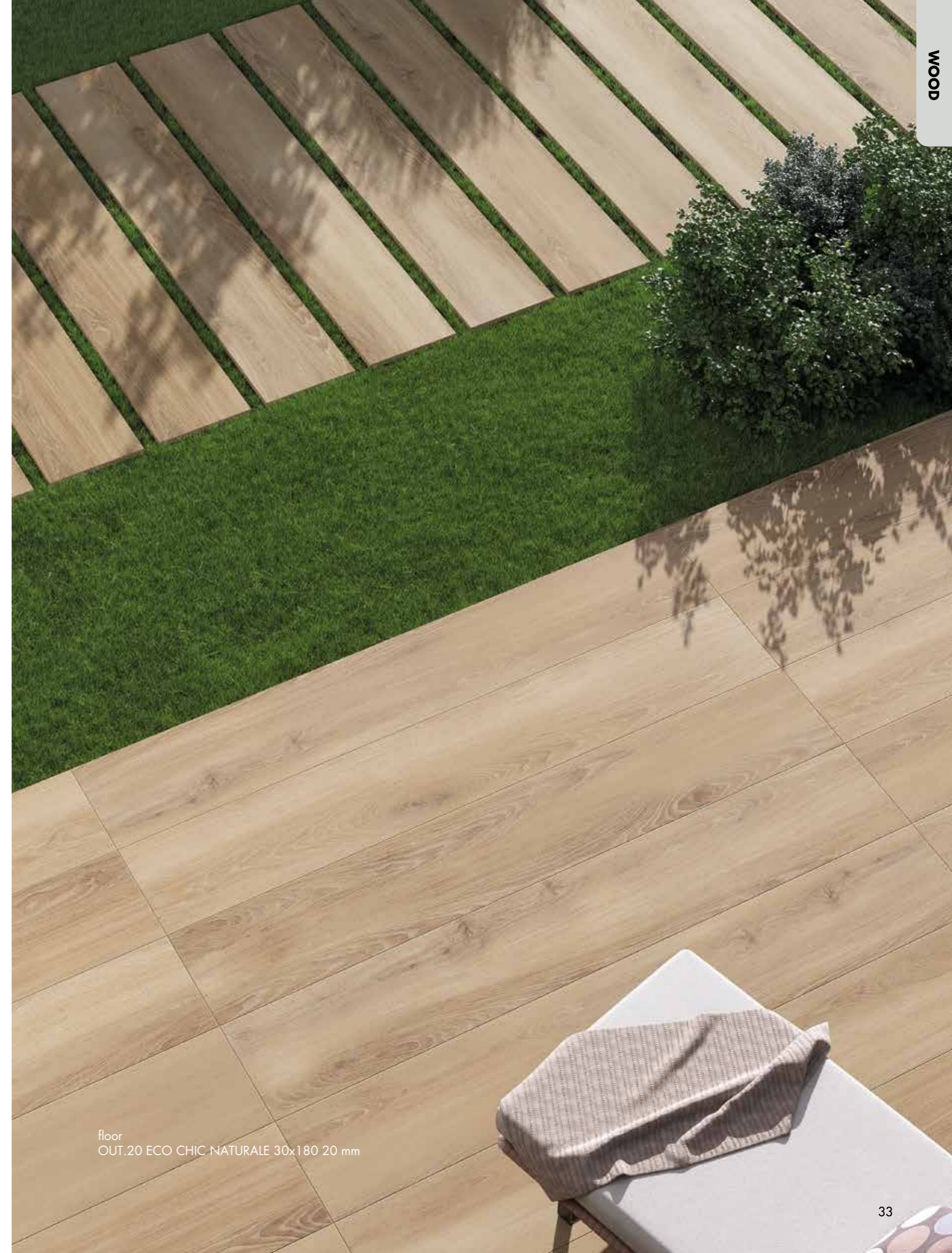

floor
OUT.20 ECO CHIC NATURALE 30x180 20 mm



wall
WIDE&STYLE RAINBOW SALVIA 120x278

floor
OUT.20 ECO CHIC AVANA 30x180 20 mm, GRIGLIA 18x90, BULLNOSE 30x180

OUT. 20

DOLPHIN

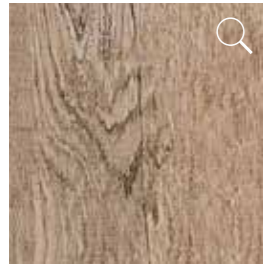

30x120
DOLPHIN CLAY
DPR57100 rett

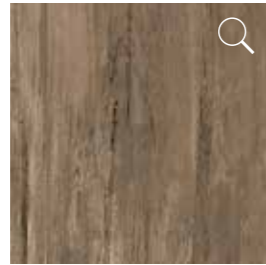

30x120
DOLPHIN OAK
DPR57150 rett

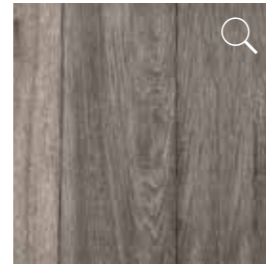

30x120
DOLPHIN GREY
DPR57250 rett

▼
20 mm
▲

Formato | Size
30x120 cm | 12"x48"

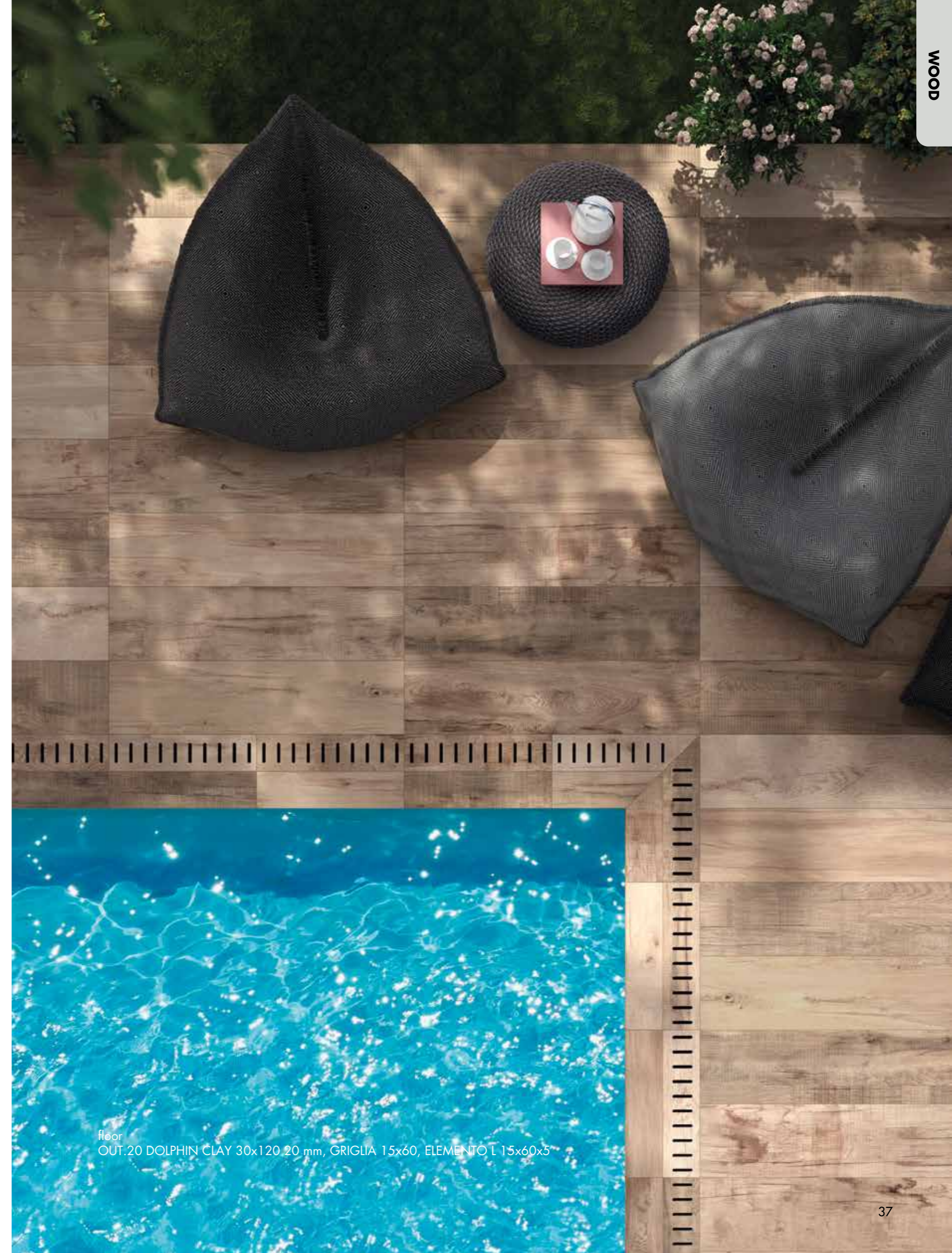
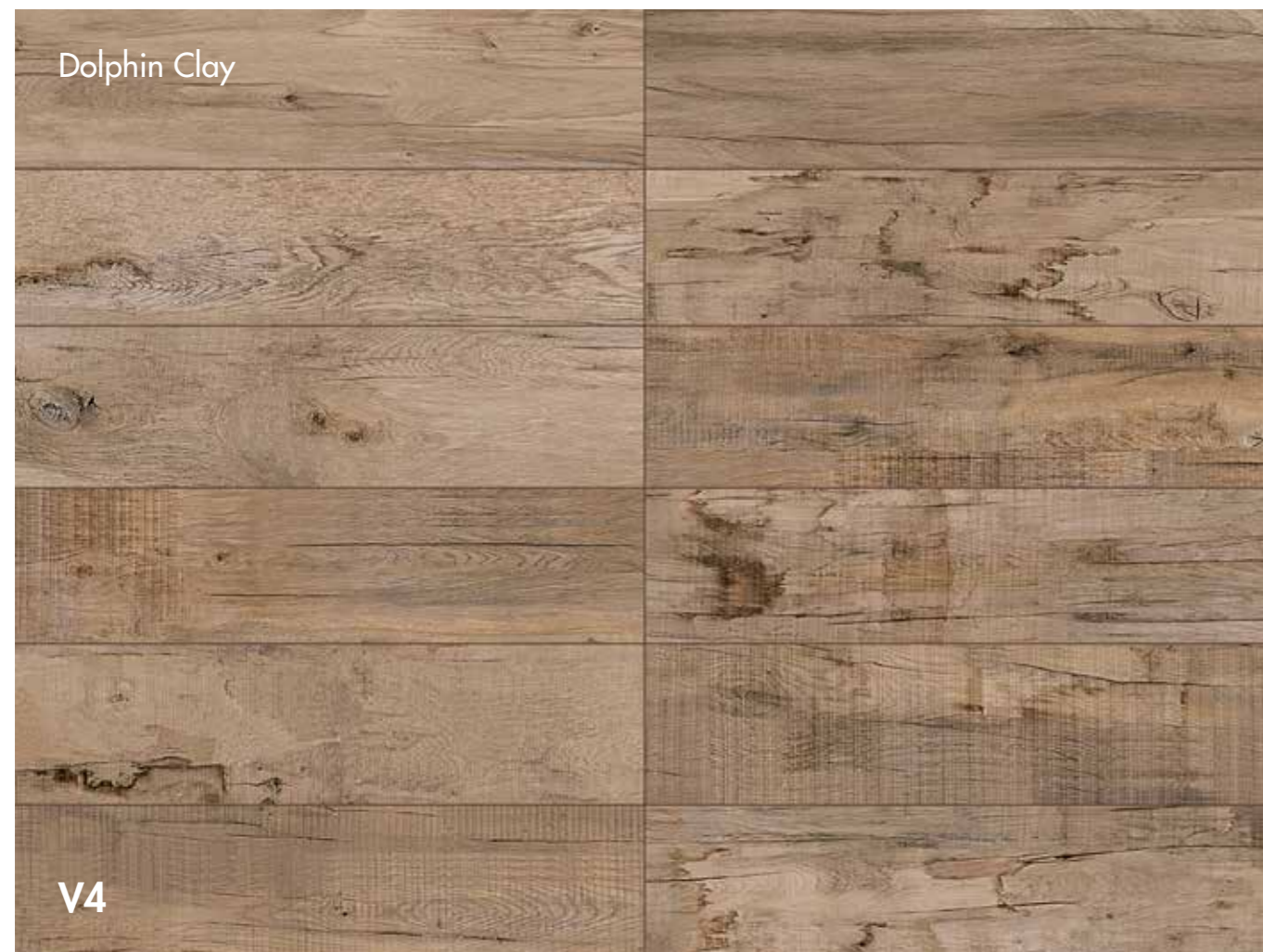

floor
OUT.20 DOLPHIN CLAY 30x120 20 mm, GRIGLIA 15x60, ELEMENTO L 15x60x5

OUT. 20

SOLERAS

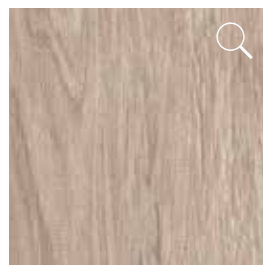

30x120
SOLERAS AVANA
51R57250 reff

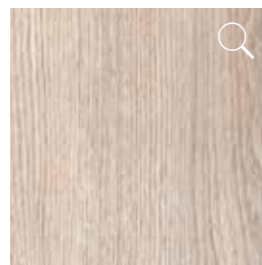

30x120
SOLERAS NATURALE
51R57200 reff

▼
20 mm
▲

Formato | Size
30x120 cm | 12"x48"

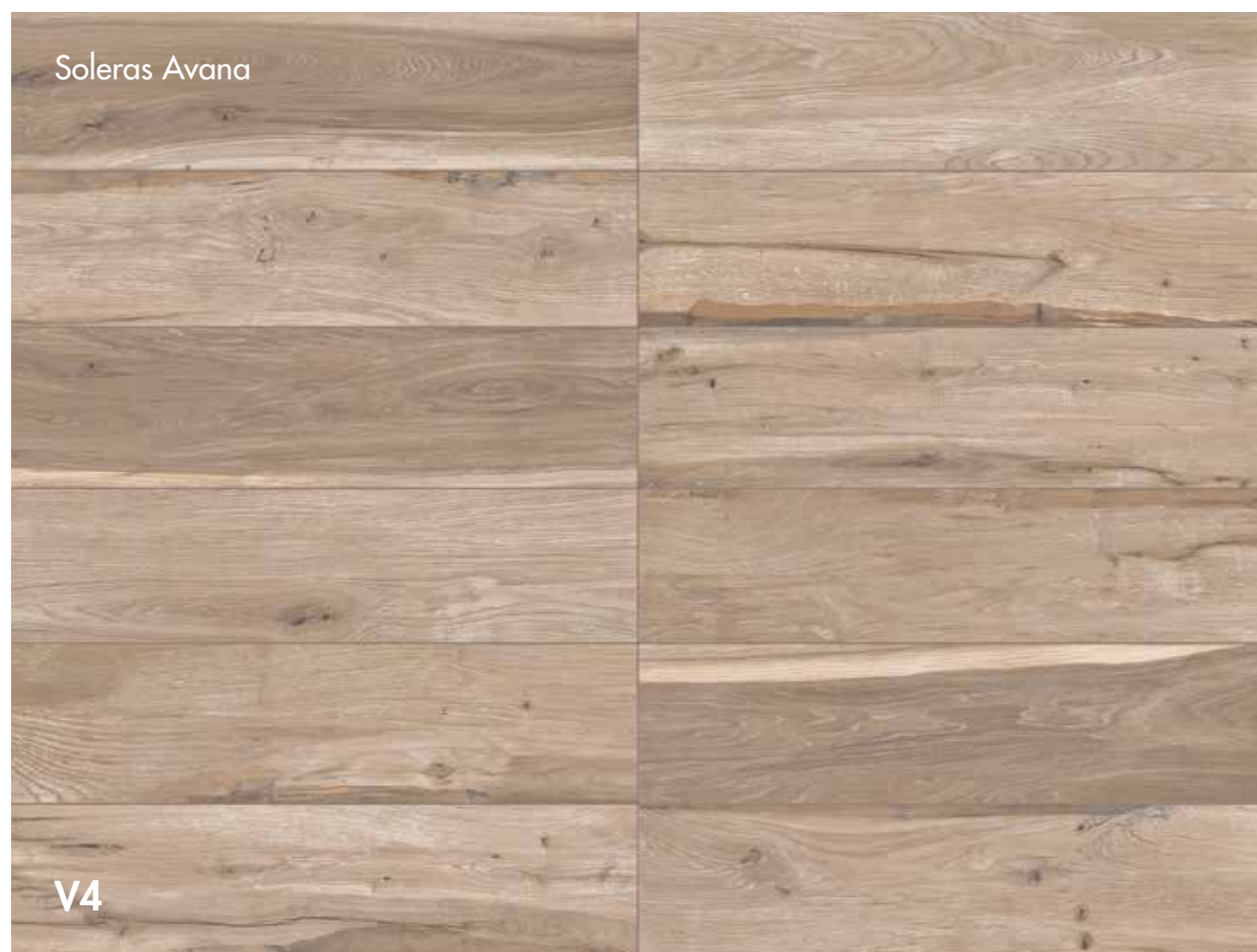

PEZZI SPECIALI

SPECIAL TRIMS

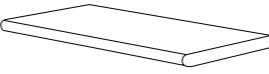
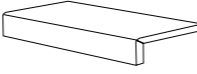
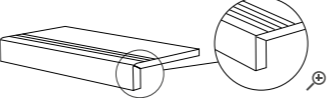
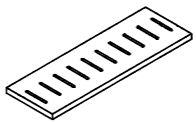
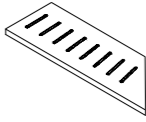
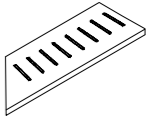
COLLEZIONI COLLECTIONS	COLORI COLOURS												
		BULLNOSE		ELEMENTO L		ELEMENTO L GRIP		GRIGLIA		ANG. GRIGLIA SX		ANG. GRIGLIA DX	
SENSI ROMA	IVORY	60x120 Rett. 20 mm ☉1	0012558	15x60x5 Rett. 20 mm ☉2	0012561	15x60x5 Rett. 20 mm ☉2	0012563	15x60 Rett. 20 mm ☉4	0012565	15x60 Rett. 20 mm ☉4	0012567	0012569	
	CREAM		0012559		0012562		0012564		0012566		0012568	0012570	
POETRY STONE	PIASE MUD	60x120 Rett. 20 mm ☉1	0010573	15x60x5 Rett. 20 mm ☉2	0010616	15x60x5 Rett. 20 mm ☉2	0010618	15x60 Rett. 20 mm ☉4	0010620	15x60 Rett. 20 mm ☉4	0010622	0010624	
	PIASE ASH		0010572		0010615		0010617		0010619		0010621	0010623	
	PIRENEI GREY		0007836		0006359		0007073		006362		006365	006368	
	PIRENEI ECRU		0011102		0006357		0011103		006360		006363	006366	
	TRANI BEIGE		0010633		0010634		0010635		0010636		0010637	0010638	
MONOLITH	FOG	60x60 Rett. 20 mm ☉1	0013577	15x60x5 Rett. 20 mm ☉2	0002393	15x60x5 Rett. 20 mm ☉2	0007063	15x60 Rett. 20 mm ☉4	0002396	15x60 Rett. 20 mm ☉4	0002399	0002402	
	GREIGE		0013576		0002392		0007062		0002395		0002398	0002401	
	SAND		0013575		0013578		0013581		0013584		0013587	0013590	
ATLANTIS	GREY HAMMERED	60x90 Rett. 20 mm ☉1	0007854	15x60x5 Rett. 20 mm ☉2	0007009	15x60x5 Rett. 20 mm ☉2	0007012	15x60 Rett. 20 mm ☉4	0007015	15x60 Rett. 20 mm ☉4	0007018	0007021	
	SMOKE HAMMERED		0007855		0007010		0007013		0007016		0007019	0007022	
	SAND HAMMERED		0008261		0007011		0007014		0007017		0007020	0007023	
	MOON HAMMERED		0007856		0007781		0007782		0007783		0007784	0007785	
NATIVE	ASH	90x90 Rett. 20 mm ☉1	0007846	15x90x5 Rett. 20 mm ☉2	0004222	15x90x5 Rett. 20 mm ☉2	0007002	18x90 Rett. 20 mm ☉2	0004225	18x90 Rett. 20 mm ☉2	0004228	0004231	
	FOG		0007847		0004223		0007003		0004226		0004229	0004232	
BLEND CONCRETE	MOON	90x90 Rett. 20 mm ☉1	0009709	15x90x5 Rett. 20 mm ☉2	0009226	15x90x5 Rett. 20 mm ☉2	0009227	18x90 Rett. 20 mm ☉2	0009228	18x90 Rett. 20 mm ☉2	0009229	0009230	
	GREY		0009708		0006021		0015170		0006023		0006025	0006027	
	ASH		0009707		0007026		0007028		0007030		0007032	0007034	
LAB 3 2 5	BASE ASH 60x120	60x120 Rett. 20 mm ☉1	0007826	15x60x5 Rett. 20 mm ☉2	0002707	15x60x5 Rett. 20 mm ☉2	0006999	15x60 Rett. 20 mm ☉4	0002709	15x60 Rett. 20 mm ☉4	0002711	0002713	
	BASE TAUPE 60x120		0007827		0002708		0007000		0002710		0002712	0002714	
	BASE ASH 60x60	30x60 Rett. 20 mm ☉1	0013049	15x60x5 Rett. 20 mm ☉2	0002707	15x60x5 Rett. 20 mm ☉2	0006999	15x60 Rett. 20 mm ☉4	0002709	15x60 Rett. 20 mm ☉4	0002711	0002713	
	BASE SAND 60x60		0013050		0008925		0008926		0008927		0008929	0008928	
GHOST	GREY	-	-	15x90x5 Rett. 20 mm ☉2	0004589	15x90x5 Rett. 20 mm ☉2	0007004	18x90 Rett. 20 mm ☉2	0004591	18x90 Rett. 20 mm ☉2	0004593	0004595	
	ROPE		-		0004590		0007005		0004592		0004594	0004596	
POETRY WOOD	GOLD	30x120 Rett. 20 mm ☉1	0010418	15x60x5 Rett. 20 mm ☉2	0010420	15x60x5 Rett. 20 mm ☉2	0010422	15x60 Rett. 20 mm ☉4	0010424	15x60 Rett. 20 mm ☉4	0010426	0010428	
	OAK		0010419		0010421		0010423		0010425		0010427	0010429	
ECO CHIC	NATURALE	-	-	15x90x5 Rett. 20 mm ☉2	0006576	15x90x5 Rett. 20 mm ☉2	0007036	18x90 Rett. 20 mm ☉2	0006578	18x90 Rett. 20 mm ☉2	0006580	0006582	
	AVANA		-		0006577		0007037		0006579		0006581	0006583	
DOLPHIN	CLAY	-	-	15x60x5 Rett. 20 mm ☉2	DPR57101	15x60x5 Rett. 20 mm ☉2	0007121	15x60 Rett. 20 mm ☉4	DPR57102	15x60 Rett. 20 mm ☉4	DPR57103	DPR57104	
	OAK		-		DPR57151		0007122		DPR57152		DPR57153	DPR57154	
	GREY		-		DPR57251		0007123		DPR57252		DPR57253	DPR57254	
SOLERAS	NATURALE	30x120 Rett. 20 mm ☉1	0007861	15x60x5 Rett. 20 mm ☉2	S1R57201	15x60x5 Rett. 20 mm ☉2	0007124	15x60 Rett. 20 mm ☉4	S1R57202	15x60 Rett. 20 mm ☉4	S1R57203	S1R57204	
	AVANA		0007862		S1R57251		0007125		S1R57252		S1R57253	S1R57254	

INFORMAZIONI TECNICHE

TECHNICAL DETAILS



CONSIGLI PER LA SICUREZZA

Prima di movimentare le piastrelle è opportuno attenersi alle seguenti indicazioni: Viste le dimensioni ed il peso dei nostri prodotti, consigliamo sempre di utilizzare la massima prudenza nel sollevamento e nello spostamento. Prima di togliere l'imballaggio, assicurarsi che le piastrelle siano appoggiate su una superficie piana e stabile. Maneggiare sempre con cura per evitare il rischio di rottura o scheggiatura. Indicativamente tutti gli articoli di formato 900 x 600 mm e superiori dovrebbero essere spostati sempre da due persone. Indossare sempre calzature e guanti antinfortunistici quando si maneggia il prodotto. Utilizzare sempre occhiali di sicurezza e un adeguato dispositivo di protezione delle vie respiratorie durante l'uso di attrezzature di taglio. Indossare tute da lavoro in modo da proteggere la pelle dal contatto con il cemento ed evitare l'uso di indumenti larghi mentre si opera con macchine utensili. Per ulteriori indicazioni relative a salute e sicurezza, si invita a contattare il referente commerciale dell'azienda.

SAFE

Read the following instructions carefully before handling the tiles:

Due to the size and weight of our products, we always recommend using the utmost caution when lifting and handling. Ensure the products are on a level, stable surface before removing any packaging. Always handle with care to avoid the risk of breakage and chipping. As a guideline, products measuring 900 x 600 mm and larger should always be handled by two people. Always wear gloves and safety footwear when handling the product. Always use safety goggles and appropriate respiratory protection when using cutting equipment. Wear suitable work overalls to protect exposed skin from cement and avoid loose clothing when working with power tools. If you require any further health and safety guidance, please contact the company's sales representative.



PREPARAZIONE

Tutti i prodotti devono essere controllati al momento dell'arrivo in modo da poter rimediare tempestivamente ad eventuali problemi. Prestare particolare attenzione ai codici di lotto per essere sicuri che soltanto piastrelle dello stesso lotto vengano utilizzate in tutto il progetto. Nel caso in cui una o due delle piastrelle siano rotte, è consigliabile tenerle da parte in quanto potrebbero essere utili per ritagli. Si declina ogni responsabilità per eventuali ritardi o costi aggiuntivi se questi controlli preliminari non vengono eseguiti.

PREPARATION

All products must be checked on arrival, so that in the unlikely event there is a problem there is time to rectify the situation. Pay particular attention to the batch codes to ensure the same batch is being used throughout your project. Any broken tiles, assuming there are only one or two, can be put to one side as they may be useful for off-cuts. No responsibility will be accepted for any delays or additional costs incurred if these pre checks have not been completed.



ATTREZZATURE PER LA POSA

Per il buon esito di qualsiasi progetto di pavimentazione in gres porcellanato è indispensabile procurarsi guanti, occhiali protettivi e maschera antipolvere. Per la posa in esterno serviranno pala, carriola, spatola con supporto in gomma, martello di gomma, livella a bolla d'aria lunga, filo con puntine o picchetti, spazzola morbida, metro a nastro, asse in legno con bordo dritto e distanziatori per piastrelle. Per l'incollaggio servirà un adesivo specifico e per un risultato ottimale si consiglia l'utilizzo di un compattatore a piastra vibrante. Per la fase di stuccatura procurarsi un sigillante elastico per le fughe, mentre per i tagli si consiglia una taglierina ad acqua con disco diamantato di buona qualità adatto al taglio di gres porcellanato di spessore 20 mm.

INSTALLATION EQUIPMENT

All products must be checked on arrival, so that in the unlikely event there is a problem there is time to rectify the situation. Pay particular attention to the batch codes to ensure the same batch is being used throughout your project. Any broken tiles, assuming there are only one or two, can be put to one side as they may be useful for off-cuts. No responsibility will be accepted for any delays or additional costs incurred if these pre checks have not been completed.



PASSI PRELIMINARI E PREPARAZIONE DEL SOTTOFONDO

Tutte le zone pavimentate con il gres porcellanato, che siano camminamenti, patii o vialetti di ingresso, necessitano di una base stabile. La profondità, resistenza e composizione di questa base dipenderà dall'uso previsto del pavimento e dalle condizioni e composizione del terreno. Poiché ogni progetto è diverso, sarà necessario cominciare con un sopralluogo accurato per garantire la realizzazione di un sottofondo adeguato e non incorrere nel rischio di un cedimento futuro del patio con i relativi costi di ripristino.

SETTING OUT AND PREPARING THE SUBBASE

All porcelain paved areas, from paths to patios and driveways, require a stable base. The depth, strength and composition of this base varies according to the planned use of the paved surface and the condition and makeup of the existing ground. As every project is different thorough investigation and judgement will need to be made at the start of the project to ensure an adequate base is laid and to avoid future problems of sunken patios and the expense of lifting and relaying.



PENDENZE

Tutte le aree pavimentate in gres porcellanato devono essere dotate di un adeguato sistema di drenaggio che può essere realizzato inclinando le piastrelle in modo che l'acqua di superficie possa defluire lontano da eventuali edifici verso un punto di raccolta adeguato, come un canaletto di scolo o il bordo del giardino.

SLOPES

All porcelain paved areas must be adequately drained. This can be achieved by sloping the tiles to direct the surface water away from any buildings towards a suitable disposal point, such as a gully, drain or the edge of the garden, allowing circa 1.5mm for every 1000mm of paving.



PREPARAZIONE DEL SOTTOFONDO

Materiali inerti per sottofondo devono essere utilizzati per garantire stabilità e resistenza del patio. Riempire l'area scavata e rastrellare la ghiaia in modo da creare uno strato uniforme circa 30 mm sotto il livello previsto del patio. Quindi, utilizzare un compattatore a piastra vibrante per consolidare gli inerti ad un'altezza compresa di 50 mm al di sotto dell'altezza prevista del patio.

PREPARING THE SUBBASE

General subbase material aggregate is required to give strength and stability to your patio. Fill the dug-out area and rake out the aggregate to create an even layer, roughly 30 mm below the proposed height of the patio. Then using a vibrating plate compactor, consolidate the aggregate to a compressed height of 50 mm below the proposed patio height.



SCHEMI DI POSA

Ovviamente la scelta di uno schema di posa per un patio varierà a seconda del prodotto scelto, del numero di formati diversi e delle dimensioni complessive del patio. Sebbene il proprietario o il paesaggista possano dare libero sfogo alla propria creatività, gli schemi di posa più diffusi sono la posa con bordi allineati (a mo' di scacchiera) e la posa a correre, dove le piastrelle vengono posate in file della stessa larghezza ma con i bordi sfalsati. Nel caso di posa a bordi allineati, le piastrelle devono avere le stesse dimensioni, mentre con la posa a correre si possono usare piastrelle di larghezza e lunghezza diverse.

LAYING PATTERNS

Choosing a design for your patio will of course vary depending on your chosen product, the number of paving sizes and the overall size of the patio. Whilst there is no limit to you or your landscape designer's creativity, the most common arrangements are stack bond, like a chess board design, or coursed, where the paving is laid in lines or courses of the same width. Stack bond needs paving tiles of the same size, while coursed layouts rely on the porcelain tiles sharing the same width with varying lengths.



FUGHE FLESSIBILI

Le lastre di porcellanato non devono essere posate a giunto unito, consigliamo una fuga nel caso di un pavimento esterno. Utilizzare gli appositi distanziatori per creare una spaziatura uniforme tra le lastre. Le fughe devono essere riempite con uno stucco flessibile non poroso e idrorepellente. Gli stucchi cementizi a presa rapida non subiscono gli effetti delle intemperie, difficilmente si scolorano e non sono soggetti alla crescita di alghe o erbacce. Inoltre, si induriscono per formare una fuga perfetta e sono calpestabili dopo circa 90 minuti.

FLEXIBLE TILE GROUT JOINTING

Porcelain tiles should not be butt jointed, and we recommend a minimum external joint. Use tile spacers to create uniform spacing between the tiles. The tiles must be jointed with a suitable non-porous, water repellent flexible tile grout. Rapid setting cement based grouting compounds are unaffected by weather, unlikely to discolour or suffer algae and weed growth. Moreover, they harden to form a perfect joint and allow foot traffic in approximately 90 minutes.



PULIZIA E MANUTENZIONE

I pavimenti in gres porcellanato hanno la particolarità di essere resistenti alle intemperie, estremamente duri e con bassa porosità, il che li rende una soluzione ideale e a bassa manutenzione per usi esterni. Non hanno bisogno di essere coperti e possono essere facilmente puliti con un detergente delicato, spazzole di gomma o macchine idropulitrici.

CLEANING AND MAINTENANCE

Porcelain paving tiles have the unique properties of being weather resistant and extremely hard with a low porosity, which makes them an ideal low maintenance external product. They do not need to be covered and can easily be cleaned with a mild detergent, a rubber brush and a jet washer.

CONSIGLI DI POSA

ADVICE FOR LAYING



POSA TRADIZIONALE
La posa tradizionale è ideale per la realizzazione di pavimentazioni carrabili.

TRADITIONAL INSTALLATION
Traditional installation is ideal for floorings that will be driven over by vehicles.



POSA A SECCO SU GHIAIA
La posa su ghiaia permette il perfetto drenaggio delle acque piovane.

DRY INSTALLATION ON GRAVEL
Installing on gravel enables perfect drainage of rainwater.



POSA A SECCO SU ERBA
La posa diretta su erba permette di creare percorsi e camminamenti integrandosi perfettamente nell'ambiente.

DRY INSTALLATION ON GRASS
Installing directly on top of grass enables the creation of paths and walkways that blend in perfectly with the surroundings.



POSA A SECCO SU SABBIA
La posa su sabbia permette di creare percorsi e camminamenti per spiagge e stabilimenti balneari.

DRY INSTALLATION ON SAND
Installing on top of sand is ideal for creating paths and walkways on beaches and beach bars.



POSA SOPRAELEVATA DA ESTERNO
Il sistema di pavimentazione sopraelevata prevede l'utilizzo di supporti portanti di tipo autolivellante, regolabili oppure fissi che si adattano con semplicità e sicurezza ad ogni tipo di pavimento sottostante. Il sistema permette la realizzazione di piani di posa con altezze variabili, da terra, comprese fra 25 e 270 mm. L'indipendenza della pavimentazione dai supporti garantisce l'assorbimento di eventuali movimenti strutturali. Il sistema sopraelevato non necessita di massetto in cemento e consente una diminuzione del peso sulla struttura portante. Le fughe aperte fra una piastrella ed un'altra consentono un facile deflusso dell'acqua piovana evitando tutti i rischi di accumulo o di ristagno. La presenza dell'intercapedine fra il piano di calpestio e il piano di appoggio favorisce l'aerazione e l'isolamento termico. Questa soluzione permette inoltre il passaggio di impianti e tubazioni nell'intercapedine, e la facile ispezione degli stessi una volta installata la pavimentazione.

OUTDOOR RAISED LAYING SYSTEM
The raised floor system foresees the use of self-levelling, adjustable or fixed load bearing supports that easily adapt to the floor below in total safety. The system is suitable to create laying designs with variable heights from the ground, which range between 25 and 270 mm. The independence of the flooring from the supports guarantees the absorption of any structural movements. The raised system does not require a cement screed and reduces the load on the bearing structure. The open joints between the tiles allow rainwater to easily drain off, avoiding any risk of water accumulation or stagnation. The gap between the tread surface and the support surface favours ventilation and heat insulation. This solution allows for the installation of systems and piping in the gap, which can be easily inspected even once the floor has been installed.

SCHEMI DI POSA

LAYING PATTERNS

CONSUMO SUPPORTI PER PAVIMENTAZIONE SOPRAELEVATA SUPPORTS FOR RAISED LAYING SYSTEM USAGE

Formato Piastrella Tile size	Posa lineare Linear laying	Posa alternate Alternate laying
120x120 / 48"x48"	2,78 pz/m ²	2,78 pz/m ²
90x90 / 36"x36"	5 pz/m ²	5 pz/m ²
60x90 / 24"x36"	3,70 pz/m ²	3,70 pz/m ²
60x60 / 24"x24"	2,78 pz/m ²	2,78 pz/m ²
30x120 / 12"x48"	5,6 pz/m ²	5,6 pz/m ²
60x120 / 24"x48"	2,78 pz/m ²	2,78 pz/m ²
30x180 / 12"x72"	5,56 pz/m ²	5,56 pz/m ²

N.B il calcolo tiene conto di un supporto centrale in corrispondenza del lato lungo della piastrella.
N.B the calculation takes into account a central support at the long side of the tile.

ES. : POSA LINEARE
EX. : LINEAR LAYING

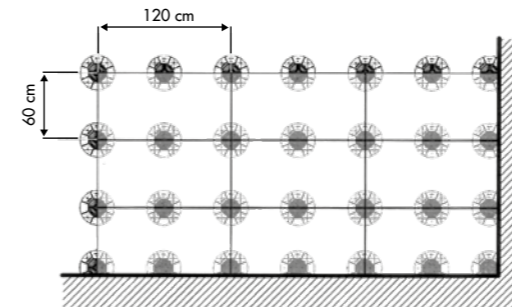

ES. : POSA ALTERNATA
EX. : ALTERNATE LAYING

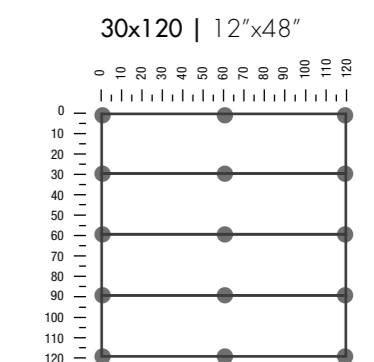
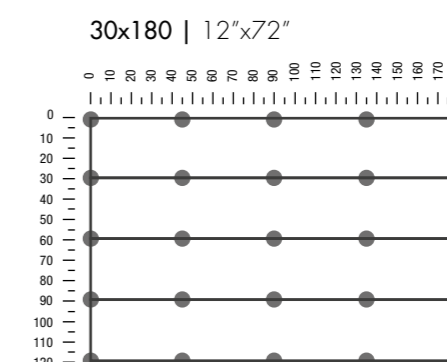
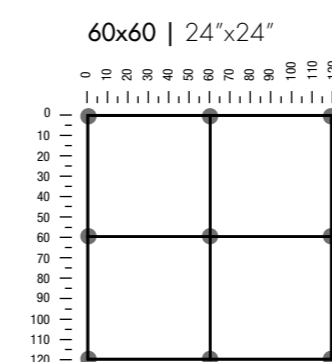
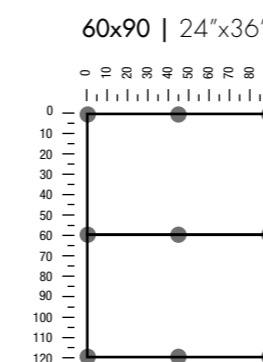
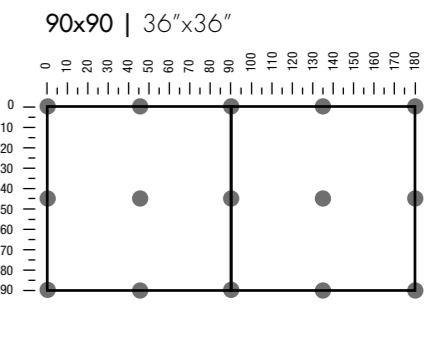
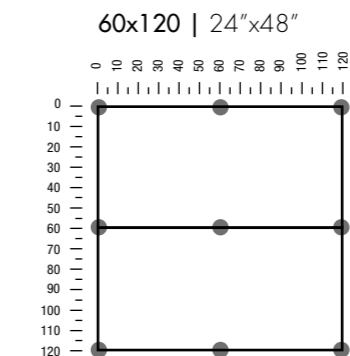
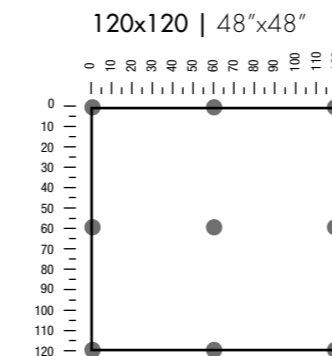
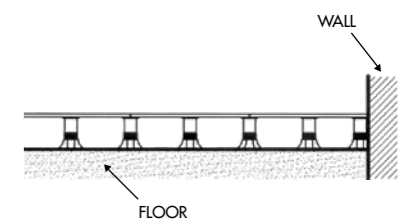
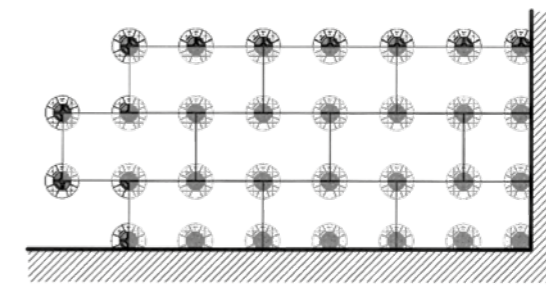

CARATTERISTICHE TECNICHE

TECHNICAL CHARACTERISTICS

CLASSIFICAZIONE SECONDO NORME UNI EN 14411 (ISO 13006) ALLEGATO G-Gruppo GL
CLASSIFICATION IN ACCORDANCE WITH UNI EN 14411 (ISO 13006) ANNEX G-Group GL

GRES PORCELLANATO A MASSA COLORATA FULL BODY COLORED PORCELAIN

PROPRIETÀ FISICO-CHIMICHE PHYSICAL-CHEMICAL PROPERTIES	NORMA NORM	VALORE PRESCRITTO DALLE NORME VALUE PRESCRIBED FROM THE NORMS	VALORE ABK OUT. 20 OUT.20 ABK VALUE
LUNGHEZZA E LARGHEZZA DIMENSIONE MEDIA DI OGNI PIASTRELLA LENGTH AND WIDTH OF THE AVERAGE-SIZES TILE	UNI EN ISO 10545/2	± 0,5%	CONFORME ACCORDING TO
SPESSORE THICKNESS	UNI EN ISO 10545/2	± 5%	CONFORME ACCORDING TO
RETTILINEARITÀ SPIGOLI WARPAGES OF EDGES	UNI EN ISO 10545/2	± 0,5%	CONFORME ACCORDING TO
ORTOGONALITÀ WEDGING	UNI EN ISO 10545/2	± 0,6%	CONFORME ACCORDING TO
PLANARITÀ FLATNESS	UNI EN ISO 10545/2	± 0,5%	CONFORME ACCORDING TO
ASSORBIMENTO D'ACQUA WATER ABSORPTION	UNI EN ISO 10545/3	E ≤ 0,5%	CONFORME ACCORDING TO
RESISTENZA ALLA FLESSIONE BENDING STRENGTH	UNI EN ISO 10545/4	≥ 35 N/mm ²	≥ 50 N/mm ²
FORZA DI ROTTURA BREAKING STRENGTH	UNI EN ISO 10545/4	≥ 1300 N	≥ 20000 N
RESISTENZA ALL'ABRAZIONE SUPERFICIALE PER PIASTRELLE SMALTATE ABRASION RESISTANCE FOR GLAZED TILES	UNI EN ISO 10545/7	IN FUNZIONE DELLA DESTINAZIONE D'USO ACCORDING TO THE DESTINATION OF FINAL USE	CONFORME ACCORDING TO
RESISTENZA AGLI SBALZI TERMICI THERMAL SHOCK RESISTANCE	UNI EN ISO 10545/9	RICHIESTA REQUIRED	RESISTE RESISTS
RESISTENZA AL GELO FROST RESISTANCE	UNI EN ISO 10545/12	RICHIESTA REQUIRED	INGELIVO FROST PROOF
RESISTENZA ALL'ATTACCO CHIMICO CHEMICAL RESISTANCE	UNI EN ISO 10545/13	MIN GB	CONFORME ACCORDING TO
RESISTENZA ALLE MACCHIE RESISTANCE TO STAINING	UNI EN ISO 10545/14	GL ≥ MINIMO CLASSE 3	CONFORME ACCORDING TO
RESISTENZA ALLO SCIVOLAMENTO SLIP RESISTANCE	B.C.R.A. C.A.	μ 0,19 SCIVOLOSITÀ PERICOLOSA - DANGEROUSLY SLIPPERY 0,20 < μ < 0,39 SCIVOLOSITÀ ECCESSIVA - EXCESSIVELY SLIPPERY 0,40 < μ < 0,74 ATTRITO SODDISFACENTE - SATISFACTORY GRIP μ 0,75 ATTRITO ECCELLENTE - EXCELLENT GRIP	>0,40
	B.C.R.A. G.B.		>0,40
	ASTM C 1028 (S.C.O.F.)	SLIP RESISTANT (> 0,60)	>0,60 DRY >0,60 WET
	DIN 51130	IN FUNZIONE DELL'AMBIENTE O DELLA ZONA DI LAVORO BASING ON THE ENVIRONMENT OR THE WORKING AREA	R11
	DIN 51097	-	A+B+C
	ANSI A 137-1:2012 (D.C.O.F.)	> 0,42	>0,42



Le caratteristiche di superficie e le tonalità dei prodotti ceramici illustrati in questo catalogo sono da ritenersi puramente indicative.
Optical features and color shades of ceramic materials illustrated in this catalogue are to be regarded as mere indications.

IMBALLI

PACKAGING

F.to nominale Nominal size	Finitura Finish	Spessore Thickness	F.to reale (mm) Work size (mm)	Imballo Packing	Pz/Scat. Pcs/Box	Mq/Scat. Sqm/Box	Kg/Scat. Kg/Box	Scat./Imb. Box/Packing	Pz Totali Pcs Total	Mq totali Sqm total	Kg Imb. Kg Packing	Kg Totali Kg Total
120x120 48"x48"	rett	20	1194x1194	pallet con sponde pallet with sides	1	1,44	69,12	18	18	25,92	40	1.284
30x180 12"x72"	rett	20	300x1800	pallet	1	0,54	26,00	48	48	25,92	20	1.268
60x120 24"x48"	rett.	20	596x1195	pallet	1	0,72	32,80	30	30	21,60	20	1.004
30x120 12"x48"	rett.	20	297x1194	pallet	2	0,72	32,80	30	60	21,60	20	1.004
90x90 36"x36"	rett.	20	896x896	pallet	1	0,81	36,50	30	30	24,30	20	1.115
60x90 24"x36"	rett.	20	596x895	pallet	1	0,54	25,00	40	40	21,60	20	1.020
60x60 24"x24"	rett.	20	596x596	pallet	2	0,72	32,80	30	60	21,60	20	1.004

L'unità minima di vendita per tutti gli articoli (fondi, decori e pezzi speciali) è la scatola completa. / The minimum sales quantity for all items (plain tiles, decorations and special trims) is one full box.

I dati relativi agli imballi sono aggiornati al momento della stampa del catalogo e pertanto possono subire variazioni nel corso del tempo. / Data referring to packaging have been update at time of printing; the actual data may be slightly different.

Pezzi speciali e decori per effetto delle lavorazioni, possono presentare variazioni di tonalità. / Due to working process special trims and decors, may show variation in tonality.

Marketing ABK Group
24.2

ABK Group Industrie Ceramiche s.p.a. - via S.Lorenzo N.24/a - 41034 Finale Emilia - Modena Italy
tel. 0535 761311 - fax 0535 761320/92800/761351

www.abk.it
#abkemozioni



ABK

EMOZIONI IN SUPERFICIE

WE
ARE **ABK**
GROUP